

Isolierstoffgekapselte Sicherheitsschalter für scharnierte Klappen I88-VKS, I88-VKW

Schutzart IP 65



Metallgekapselte Sicherheitsschalter für scharnierte Klappen GC-VKS, GC-VKW

Schutzart IP 65



Typbezeichnung

Artikelnummer

Schaltbild

⊕ Zwangsöffnung gemäß
IEC 947-5-1 Kap. 3

Za: nicht galv. getrennter Wechsler

Zb: galv. getrennter Wechsler

Schleichschaltglied/Sprungschaltglied

Dichtung innen liegend (iw)/außen liegend (w)

I88-U1Z VKS

608.6100.093

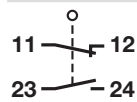

⊕ Zb

●/-

iw

I88-U1Z VKW RE

608.6100.094

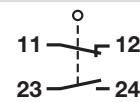

⊕ Zb

●/-

iw

Schaltwinkel Grad
Tol. ± 3.5°



Ein Aus

Betätigungs-
drehmoment Ncm
Tol. ± 10%

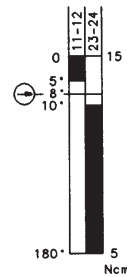
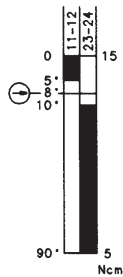

Spannung max. 500 V AC

Dauerstrom max. 10 A

Einschaltstrom gem. IEC 947-5-1 AC 15/DC 13

Schalzhäufigkeit max. 50/min.

mech. Lebensdauer – Anzahl der Schaltspiele 1 x 10⁶

Umgebungstemperatur min./max. -30 °C/+80 °C

-22 °F/+176 °F

500 V AC

10 A

●

50/min.

1 x 10⁶

-30 °C/+80 °C

-22 °F/+176 °F

500 V AC

10 A

●

50/min.

1 x 10⁶

-30 °C/+80 °C

-22 °F/+176 °F

Zulassungen

Gewicht

Lagertyp/Lieferzeit nach Vereinbarung

UL, CSA

BG

0,09 kg/0,20 lb

-/●

UL, CSA

BG

0,09 kg/0,20 lb

-/●

Alle Abmessungen in mm (inch)

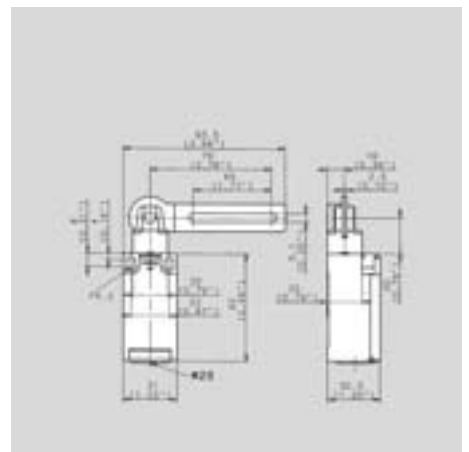
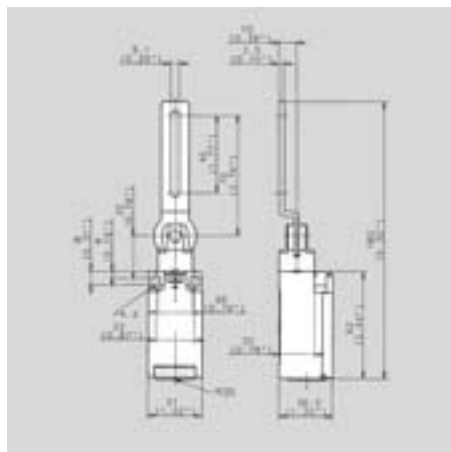



I88-U1Z VKW LI
608.6100.095

GC-U1Z VKS
612.1100.622

GC-U1Z VKW
612.1100.623

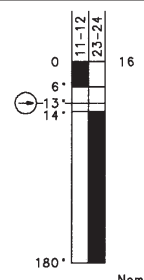
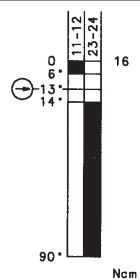
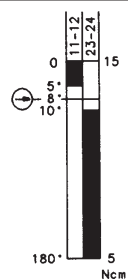
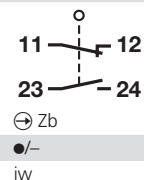
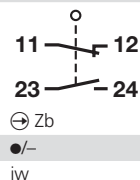
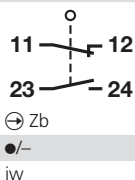

500 V AC
10 A

500 V AC
10 A

500 V AC
10 A

50/min.
1 x 10⁶
-30 °C/+80 °C
-22 °F/+176 °F

20/min.
1 x 10⁶
-30 °C/+80 °C
-22 °F/+176 °F

20/min.
1 x 10⁶
-30 °C/+80 °C
-22 °F/+176 °F

UL, CSA
BG
0,09 kg/0,20 lb
-/●

UL, CSA
BG
0,20 kg/0,44 lb
●/-

UL, CSA
BG
0,20 kg/0,44 lb
●/-

